

1

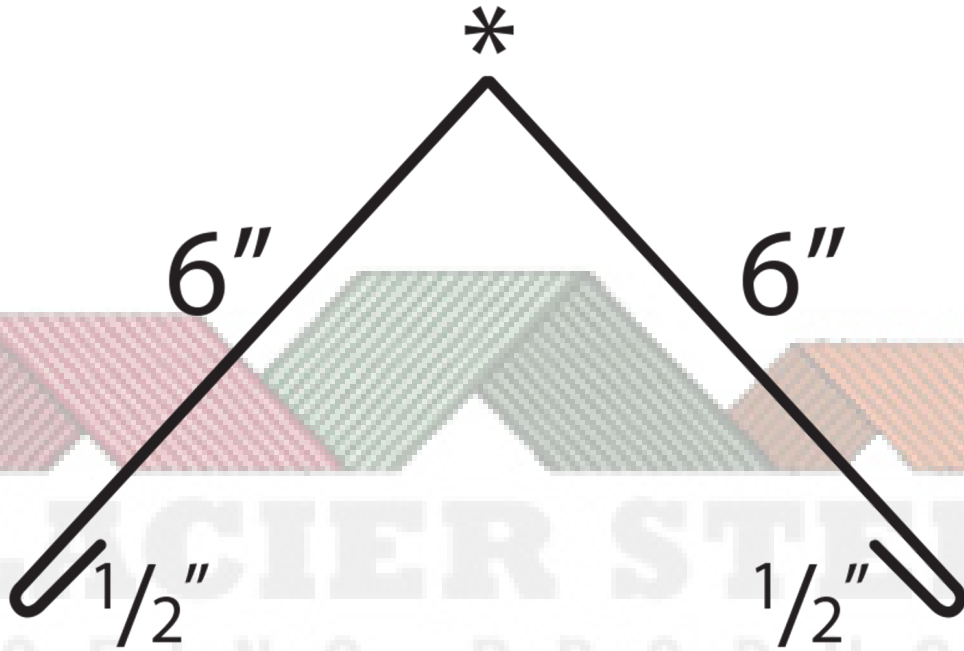

Hipcap

13"



Glacier Steel
139 Alder Dr.
Kalispell, MT 59901
PH: 406.892.7525
FX: 406.892.7526

W W W . G L A C I E R S T E E L . C O M

2

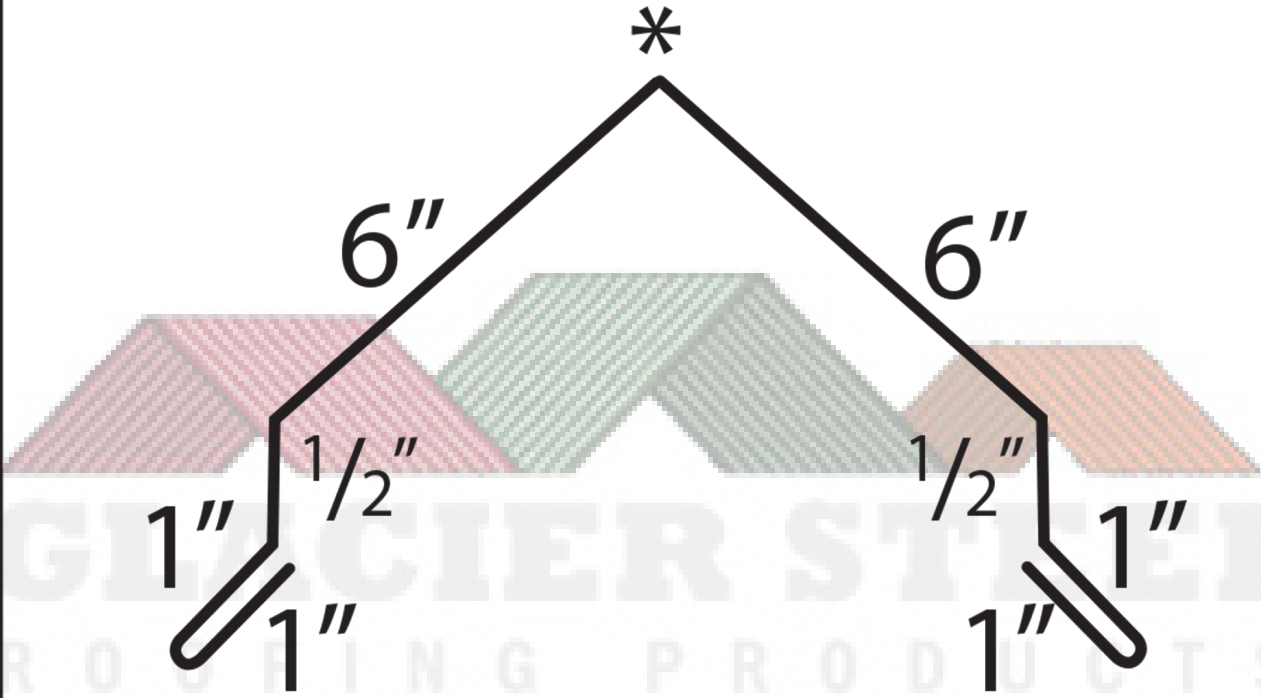

Ridgecap

17"



Glacier Steel
139 Alder Dr.
Kalispell, MT 59901
PH: 406.892.7525
FX: 406.892.7526

W W W . G L A C I E R S T E E L . C O M

3

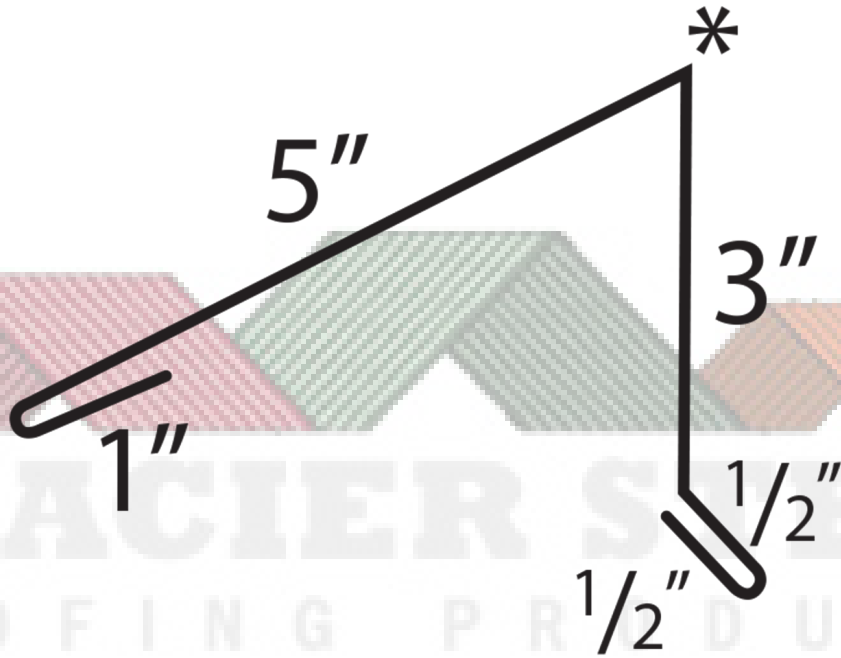

Mini Topcap

10"



Glacier Steel
139 Alder Dr.
Kalispell, MT 59901
PH: 406.892.7525
FX: 406.892.7526

W W W . G L A C I E R S T E E L . C O M

4

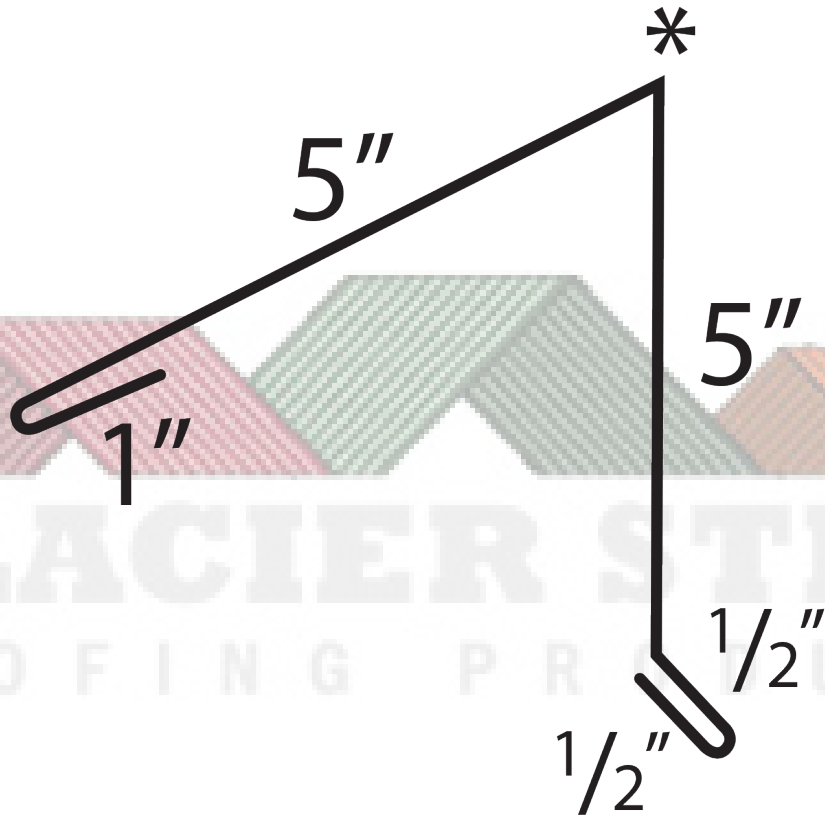

4" Topcap

12"



Glacier Steel
139 Alder Dr.
Kalispell, MT 59901
PH: 406.892.7525
FX: 406.892.7526

W W W . G L A C I E R S T E E L . C O M

5

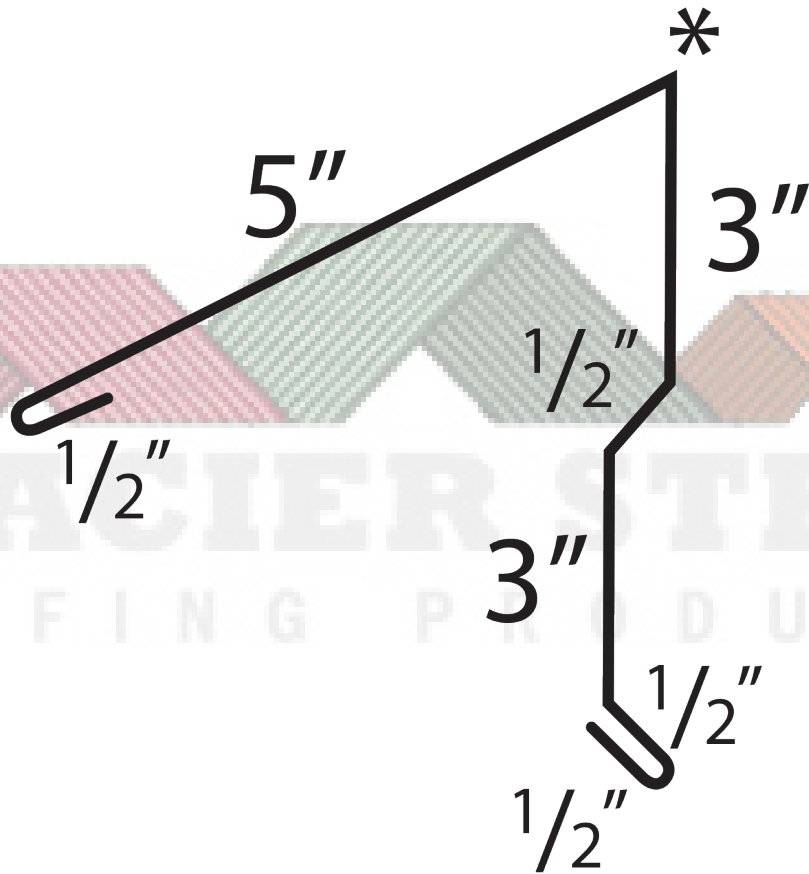

6" Topcap

13"



Glacier Steel
139 Alder Dr.
Kalispell, MT 59901
PH: 406.892.7525
FX: 406.892.7526

W W W . G L A C I E R S T E E L . C O M

6

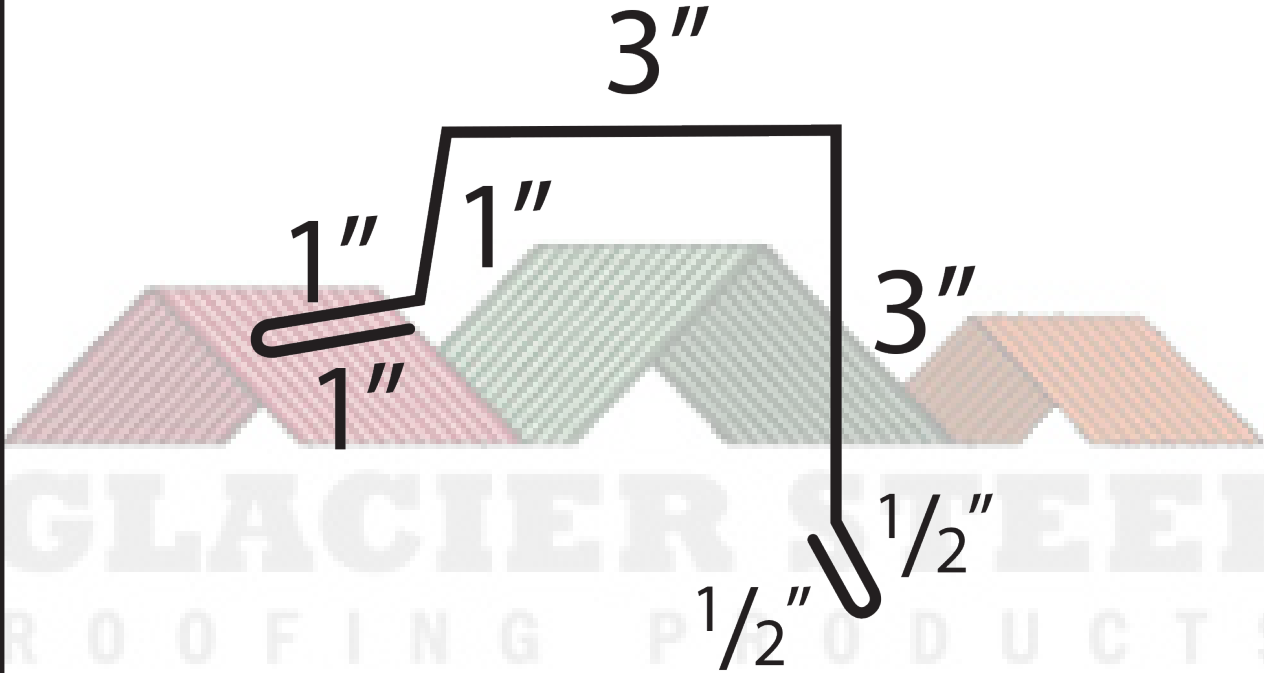

Mini Gable

10"



Glacier Steel
139 Alder Dr.
Kalispell, MT 59901
PH: 406.892.7525
FX: 406.892.7526

W W W . G L A C I E R S T E E L . C O M

7

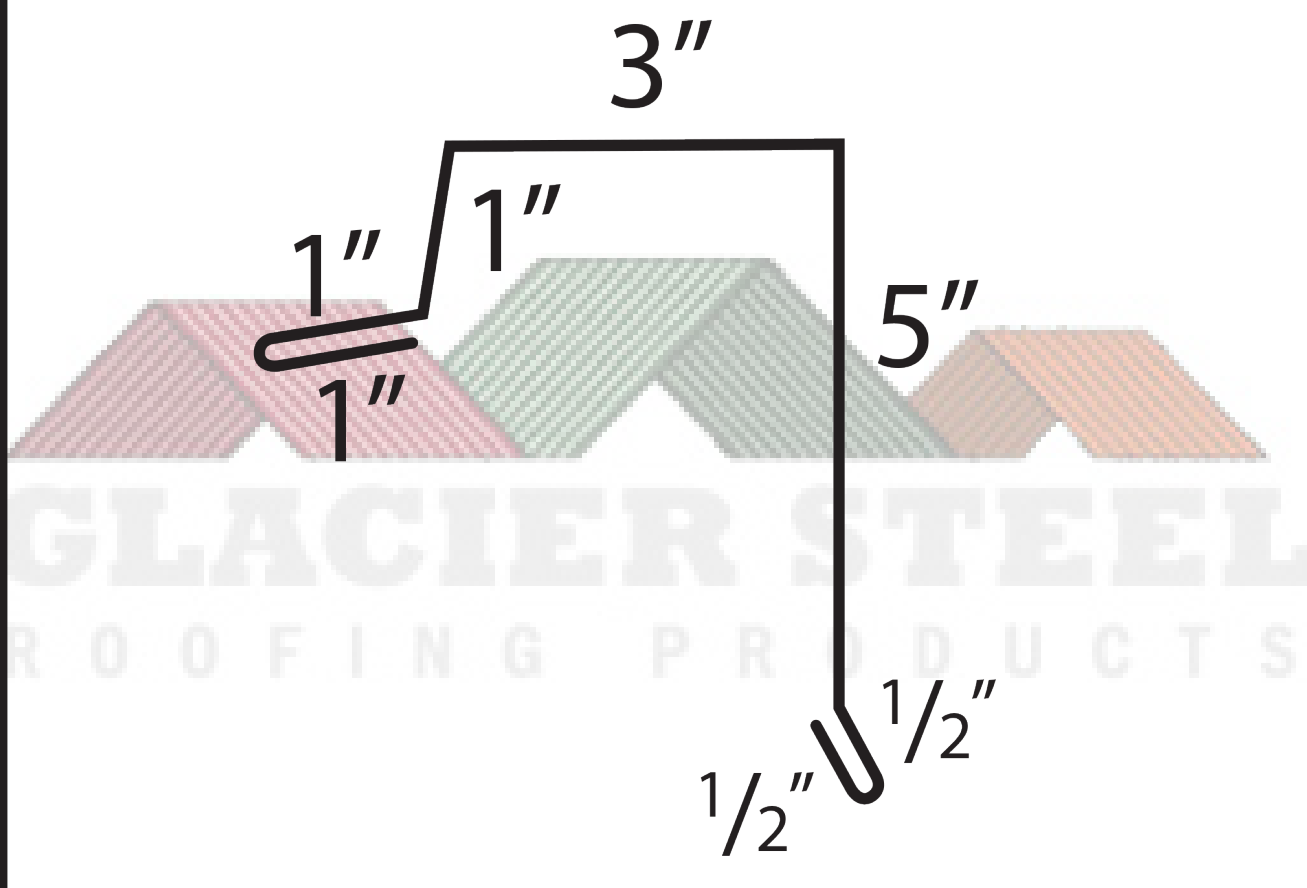

4" Gable

12"



Glacier Steel
139 Alder Dr.
Kalispell, MT 59901
PH: 406.892.7525
FX: 406.892.7526

W W W . G L A C I E R S T E E L . C O M

8

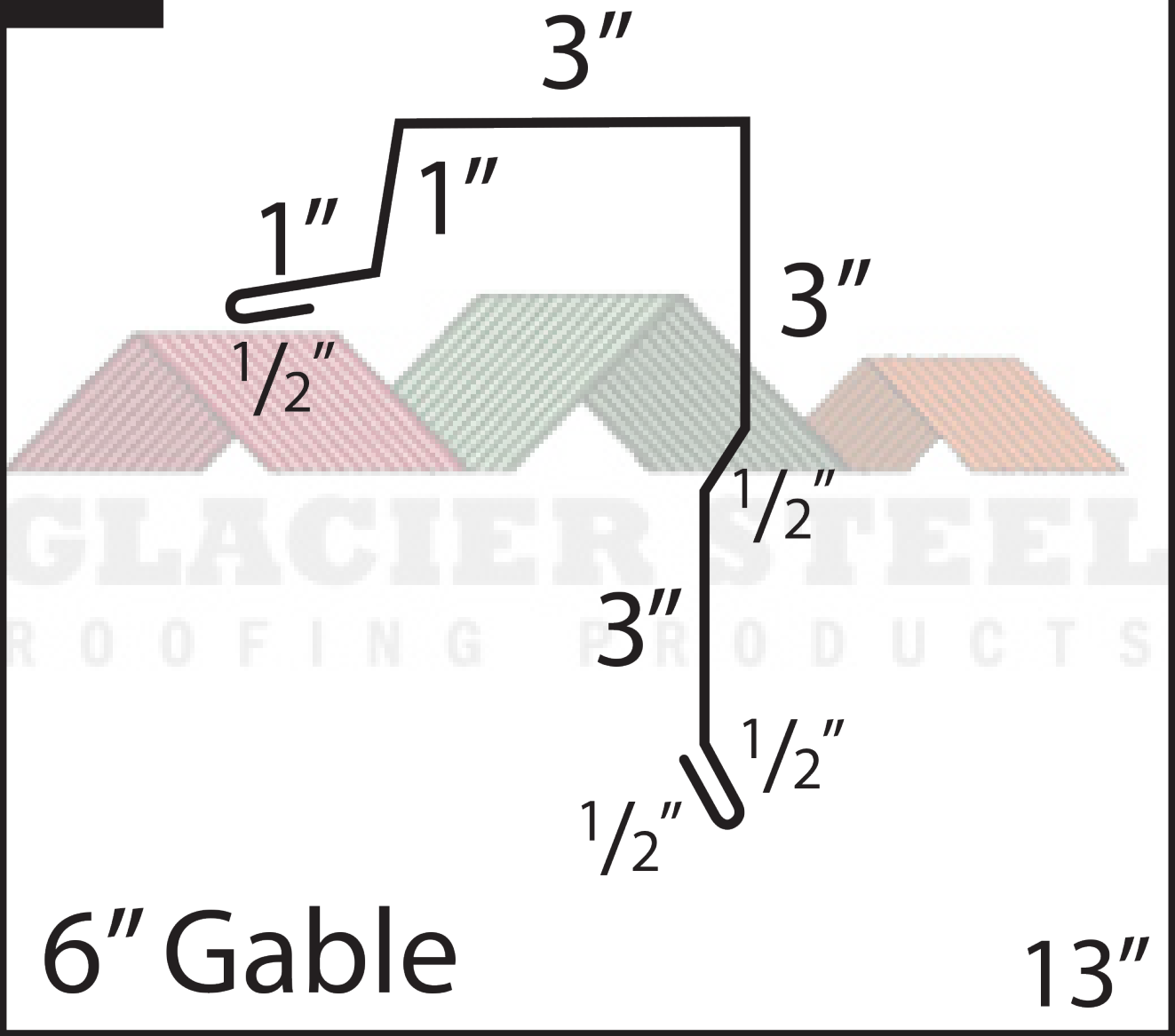

Glacier Steel
139 Alder Dr.
Kalispell, MT 59901
PH: 406.892.7525
FX: 406.892.7526

W W W . G L A C I E R S T E E L . C O M

9

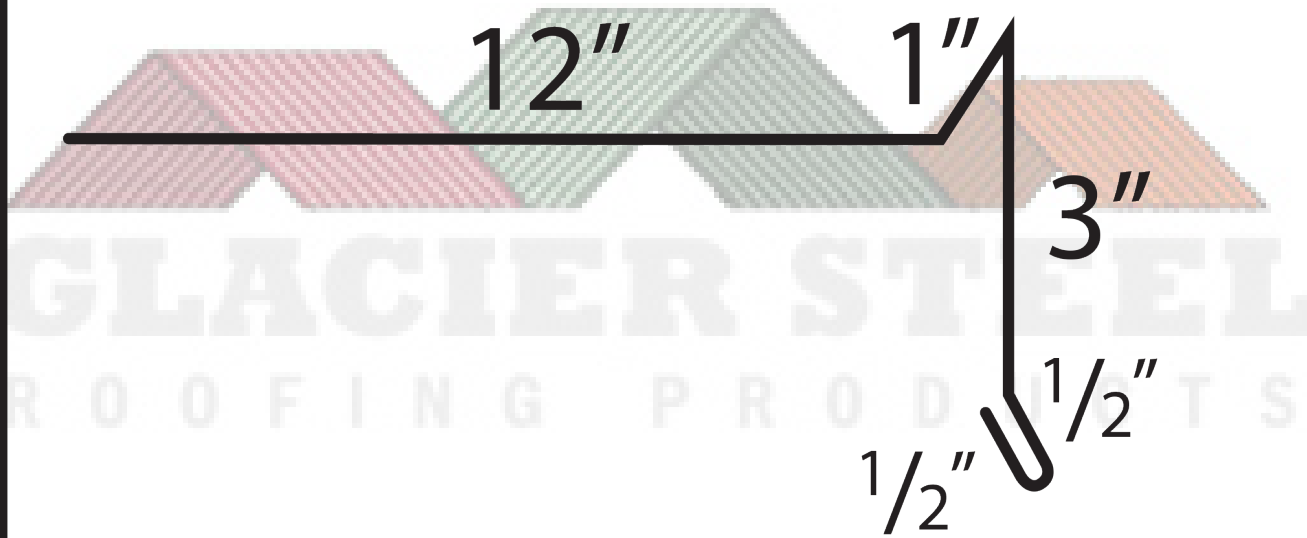

Prow Gable

17"



Glacier Steel
139 Alder Dr.
Kalispell, MT 59901
PH: 406.892.7525
FX: 406.892.7526

W W W . G L A C I E R S T E E L . C O M

10



Gravel Stop

17"



Glacier Steel
139 Alder Dr.
Kalispell, MT 59901
PH: 406.892.7525
FX: 406.892.7526

W W W . G L A C I E R S T E E L . C O M

11

11"

1" 1"

11"

W-Valley

24"

GLACIER STEEL
ROOFING PRODUCTS

12"

12"

V-Valley

24"



Glacier Steel
139 Alder Dr.
Kalispell, MT 59901
PH: 406.892.7525
FX: 406.892.7526

W W W . G L A C I E R S T E E L . C O M

12

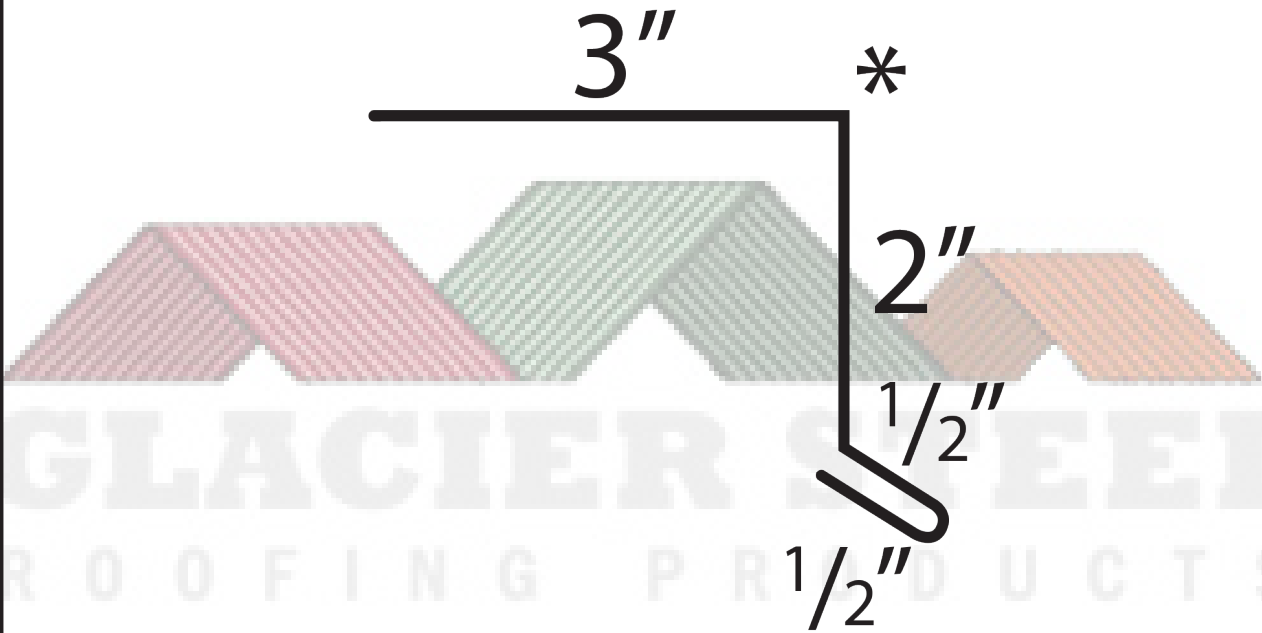

Mini Eave

6"



Glacier Steel
139 Alder Dr.
Kalispell, MT 59901
PH: 406.892.7525
FX: 406.892.7526

W W W . G L A C I E R S T E E L . C O M

13

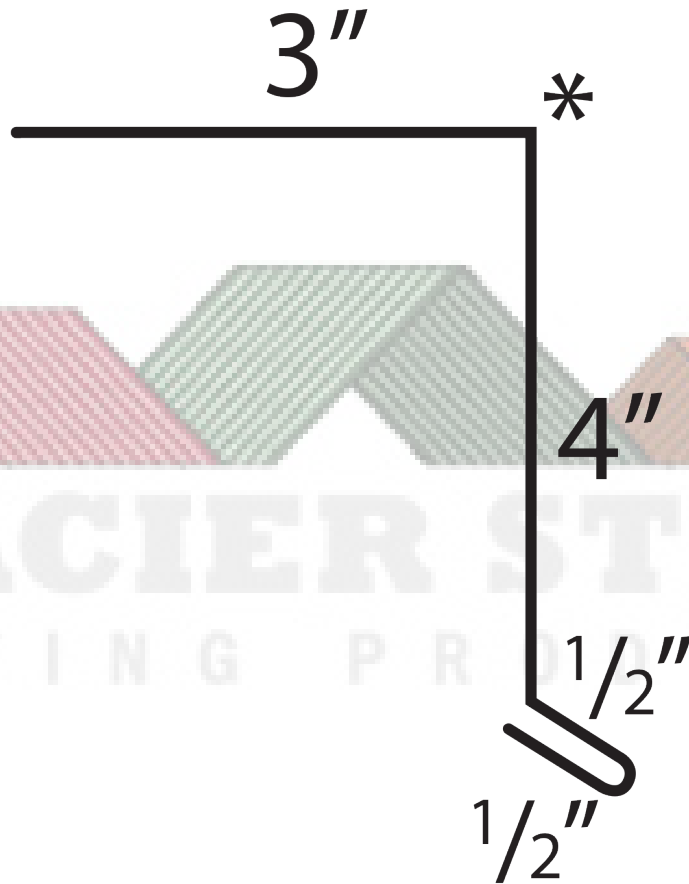

4" Eave

8"



Glacier Steel
139 Alder Dr.
Kalispell, MT 59901
PH: 406.892.7525
FX: 406.892.7526

W W W . G L A C I E R S T E E L . C O M

14



6" Eave

10"



Glacier Steel
139 Alder Dr.
Kalispell, MT 59901
PH: 406.892.7525
FX: 406.892.7526

W W W . G L A C I E R S T E E L . C O M

15

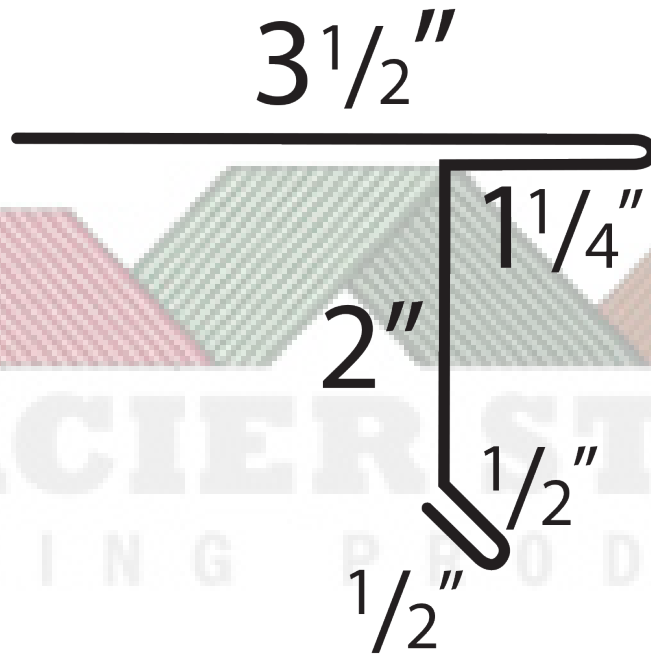

Style "D"

9"



Glacier Steel
139 Alder Dr.
Kalispell, MT 59901
PH: 406.892.7525
FX: 406.892.7526

W W W . G L A C I E R S T E E L . C O M

16

Specify
Length



Fascia



Glacier Steel
139 Alder Dr.
Kalispell, MT 59901
PH: 406.892.7525
FX: 406.892.7526

W W W . G L A C I E R S T E E L . C O M

17

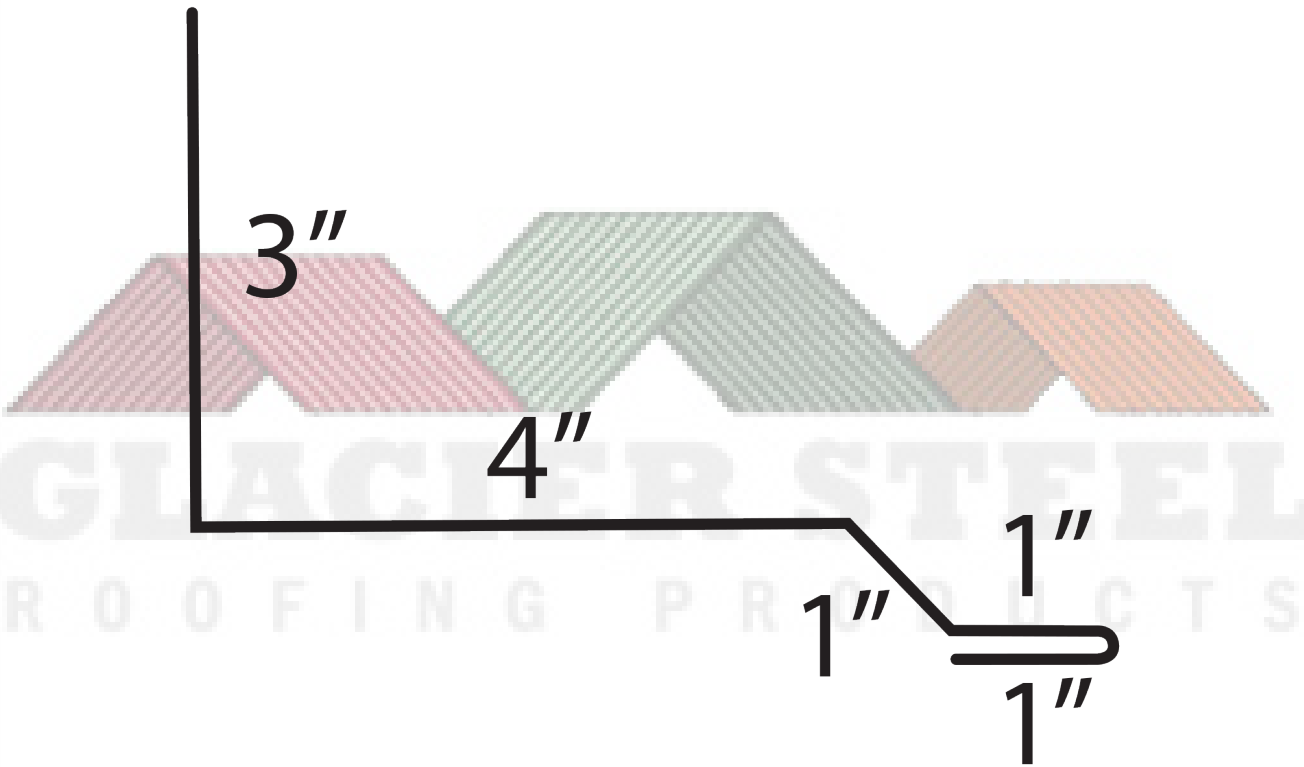

Sidewall

10"



Glacier Steel
139 Alder Dr.
Kalispell, MT 59901
PH: 406.892.7525
FX: 406.892.7526

W W W . G L A C I E R S T E E L . C O M

18

4"

*

5"

1"

10"

Endwall



GLACIER STEEL
ROOFING PRODUCTS



Glacier Steel
139 Alder Dr.
Kalispell, MT 59901
PH: 406.892.7525
FX: 406.892.7526

W W W . G L A C I E R S T E E L . C O M

19

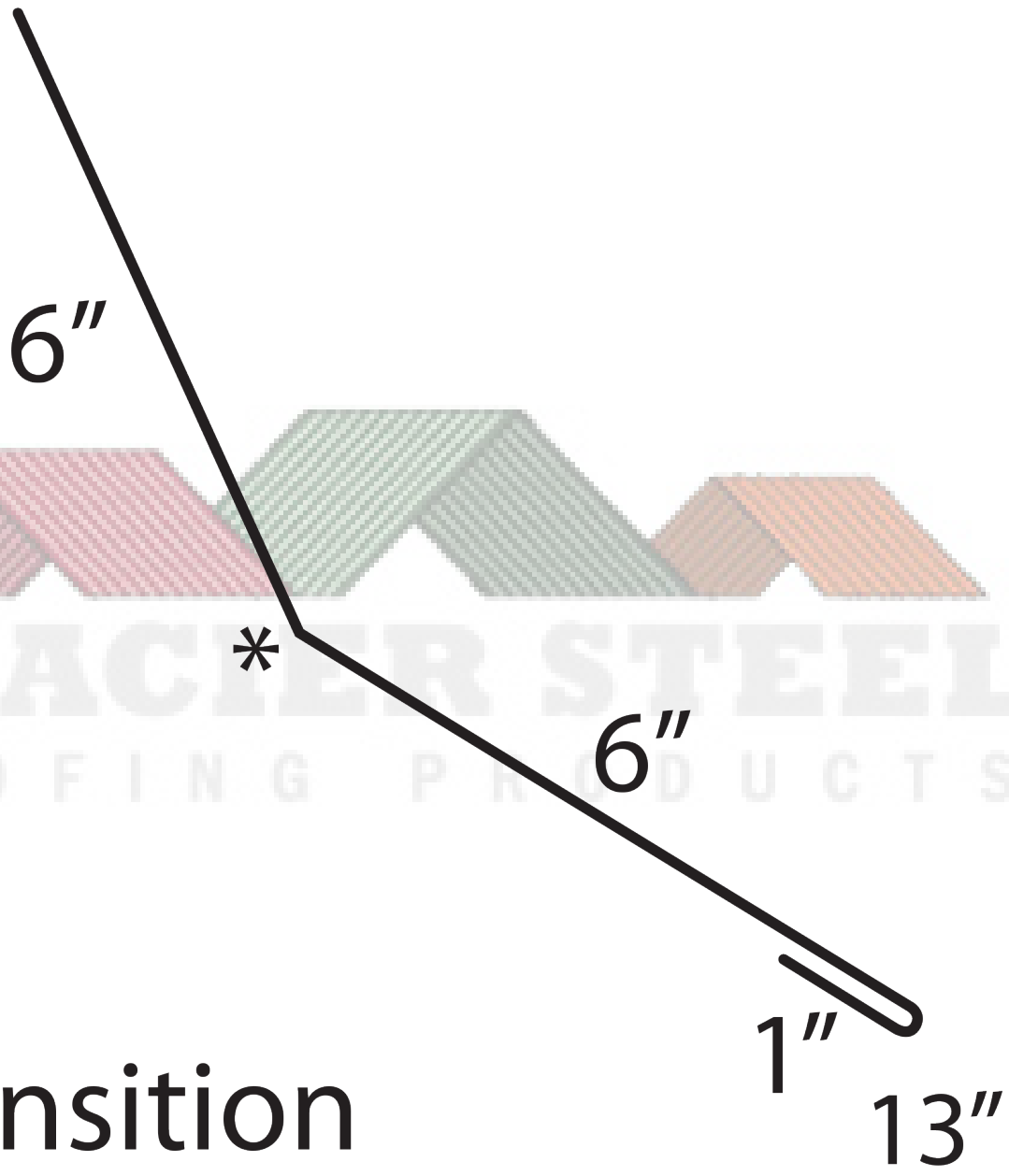

Transition



Glacier Steel
139 Alder Dr.
Kalispell, MT 59901
PH: 406.892.7525
FX: 406.892.7526

W W W . G L A C I E R S T E E L . C O M

20

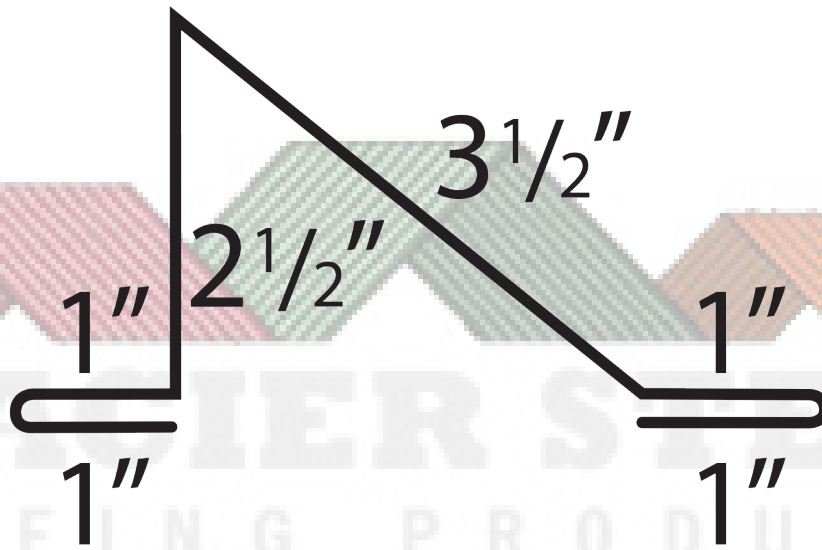

Snowbrake

10"



Glacier Steel
139 Alder Dr.
Kalispell, MT 59901
PH: 406.892.7525
FX: 406.892.7526

W W W . G L A C I E R S T E E L . C O M

21

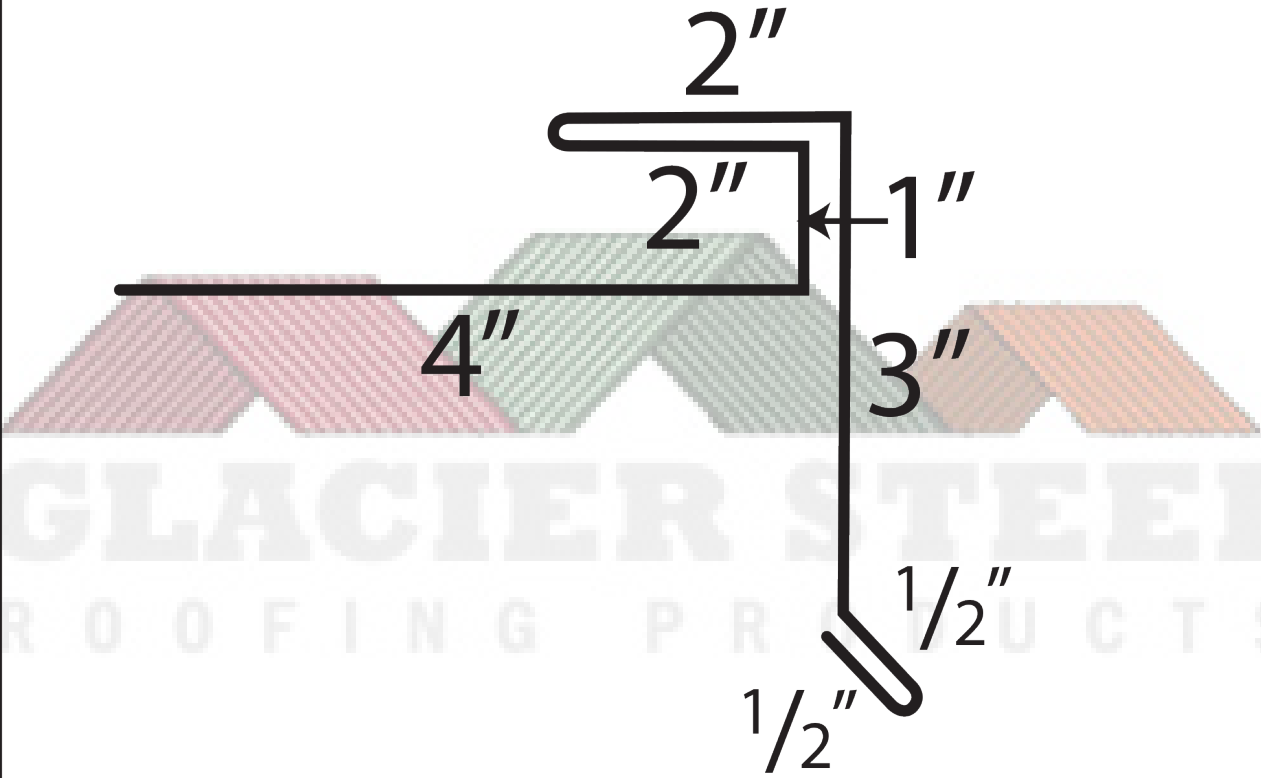

C-Gable

13"



Glacier Steel
139 Alder Dr.
Kalispell, MT 59901
PH: 406.892.7525
FX: 406.892.7526

W W W . G L A C I E R S T E E L . C O M

22

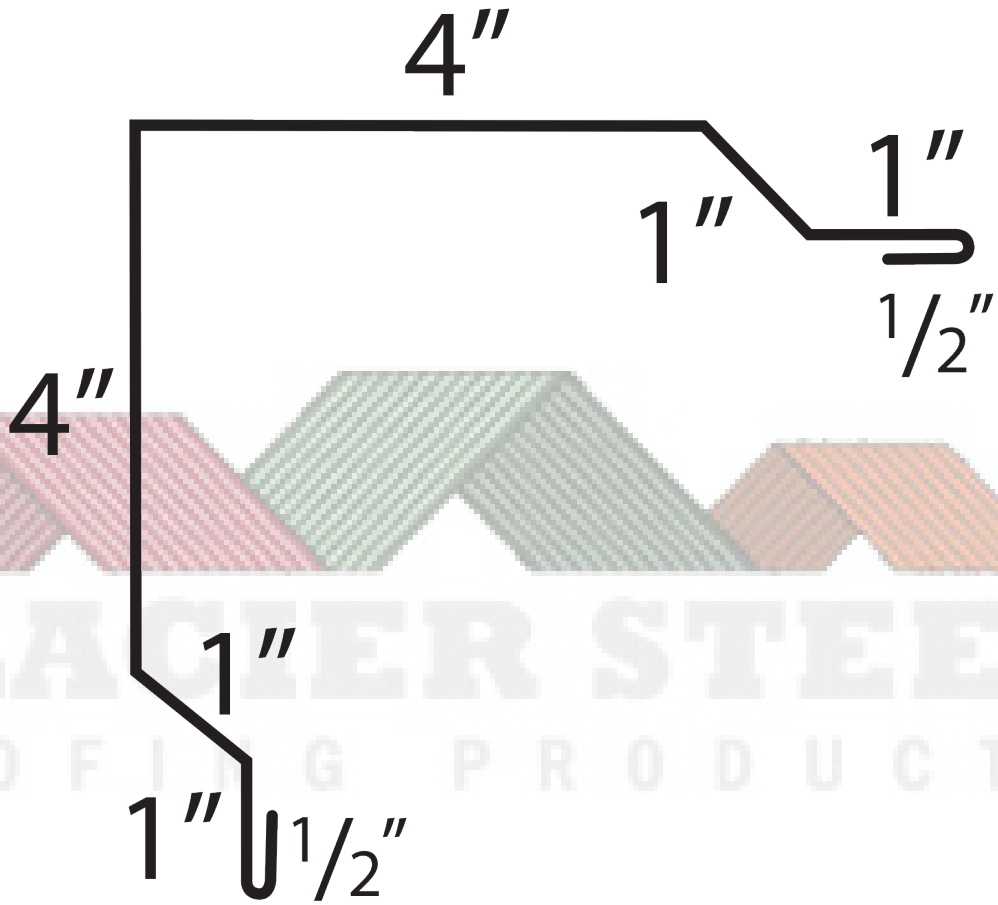

GLACIER STEEL
ROOFING PRODUCTS

Outside Corner

13"



Glacier Steel
139 Alder Dr.
Kalispell, MT 59901
PH: 406.892.7525
FX: 406.892.7526

W W W . G L A C I E R S T E E L . C O M

23

1 1/2" 1"

1"

4"

4"

1"

1"

1 1/2"

Inside Corner

13"

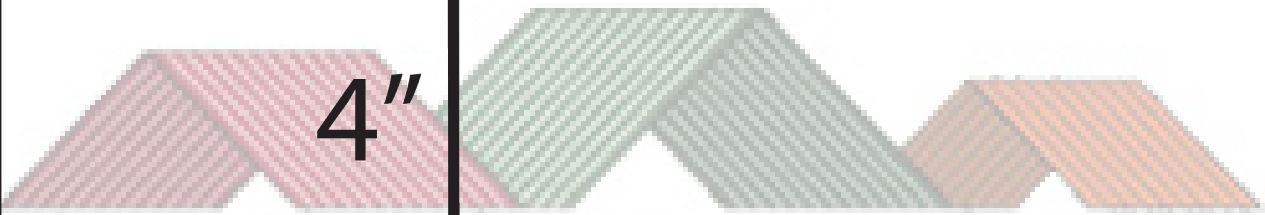

GLACIER STEEL
ROOFING PRODUCTS



Glacier Steel
139 Alder Dr.
Kalispell, MT 59901
PH: 406.892.7525
FX: 406.892.7526

W W W . G L A C I E R S T E E L . C O M

24

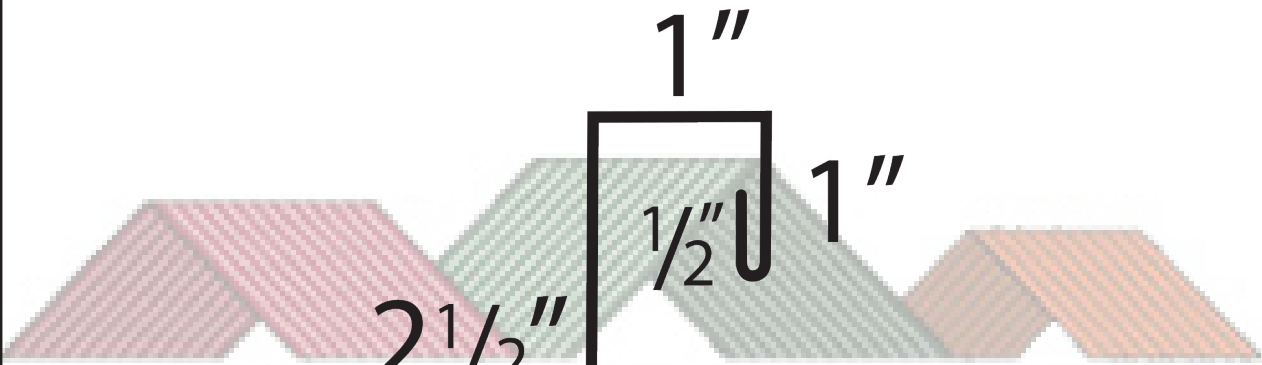

GLACIER STEEL
ROOFING PRODUCTS

J-Metal

5"



Glacier Steel
139 Alder Dr.
Kalispell, MT 59901
PH: 406.892.7525
FX: 406.892.7526

W W W . G L A C I E R S T E E L . C O M

25

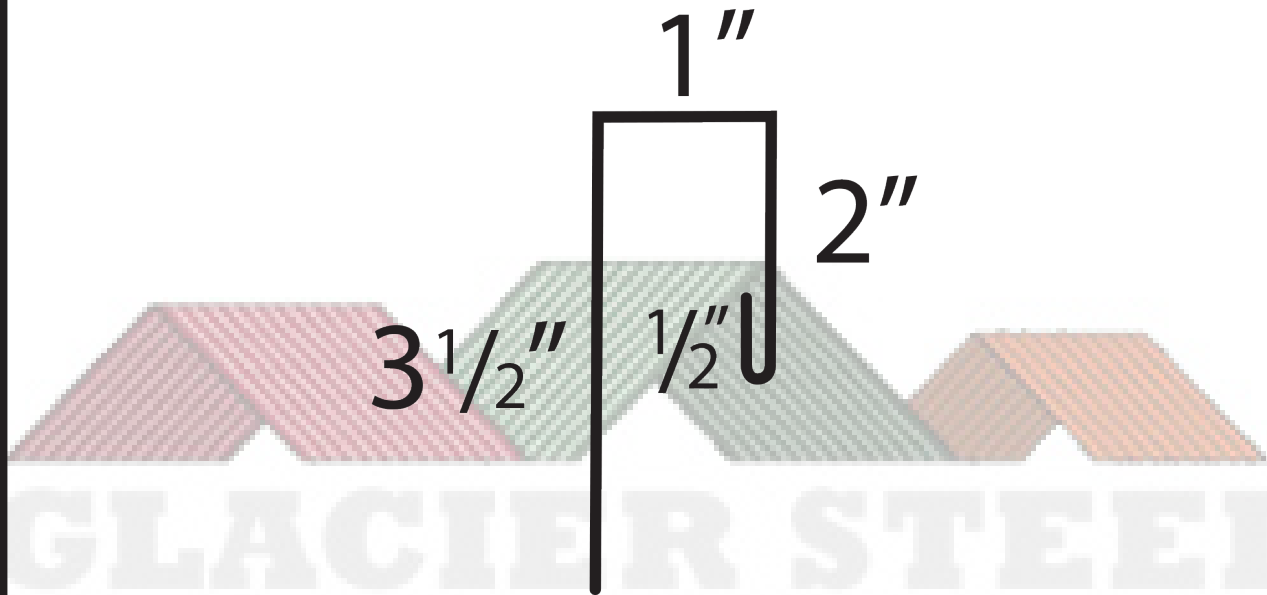

GLACIER STEEL
ROOFING PRODUCTS

2" J-Metal

7"



Glacier Steel
139 Alder Dr.
Kalispell, MT 59901
PH: 406.892.7525
FX: 406.892.7526

W W W . G L A C I E R S T E E L . C O M

26

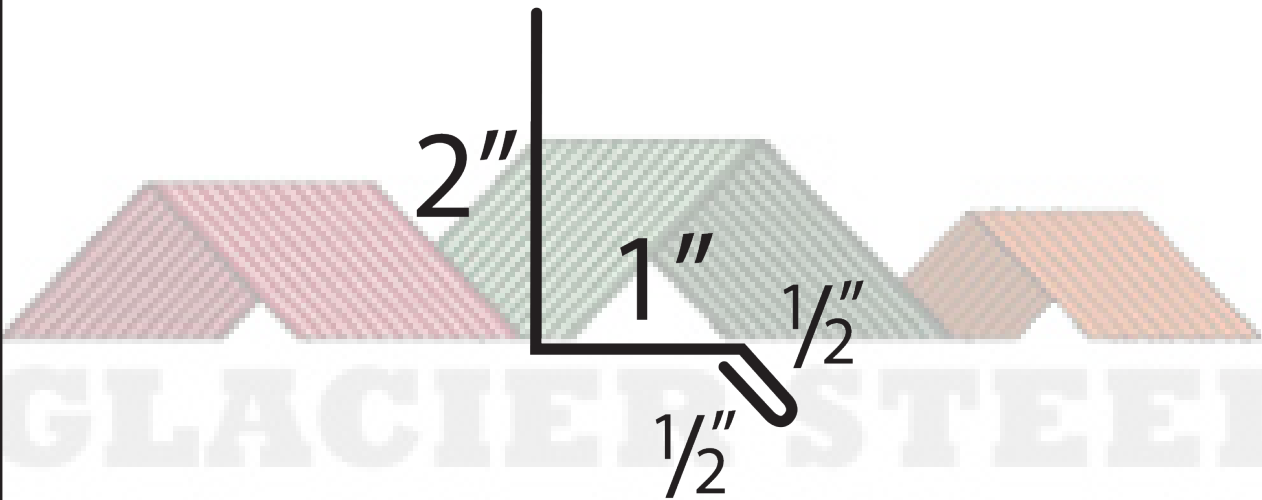

GLACIER STEEL
ROOFING PRODUCTS

Basemetal

4"



Glacier Steel
139 Alder Dr.
Kalispell, MT 59901
PH: 406.892.7525
FX: 406.892.7526

W W W . G L A C I E R S T E E L . C O M

27

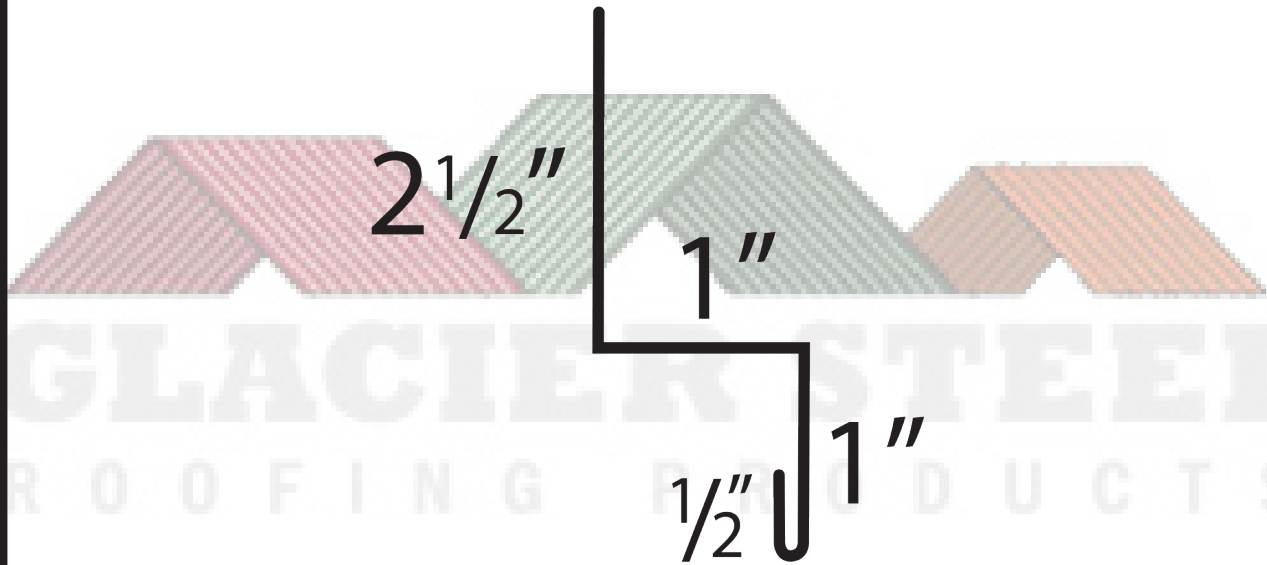

Wall Transition

5"



Glacier Steel
139 Alder Dr.
Kalispell, MT 59901
PH: 406.892.7525
FX: 406.892.7526

W W W . G L A C I E R S T E E L . C O M

28

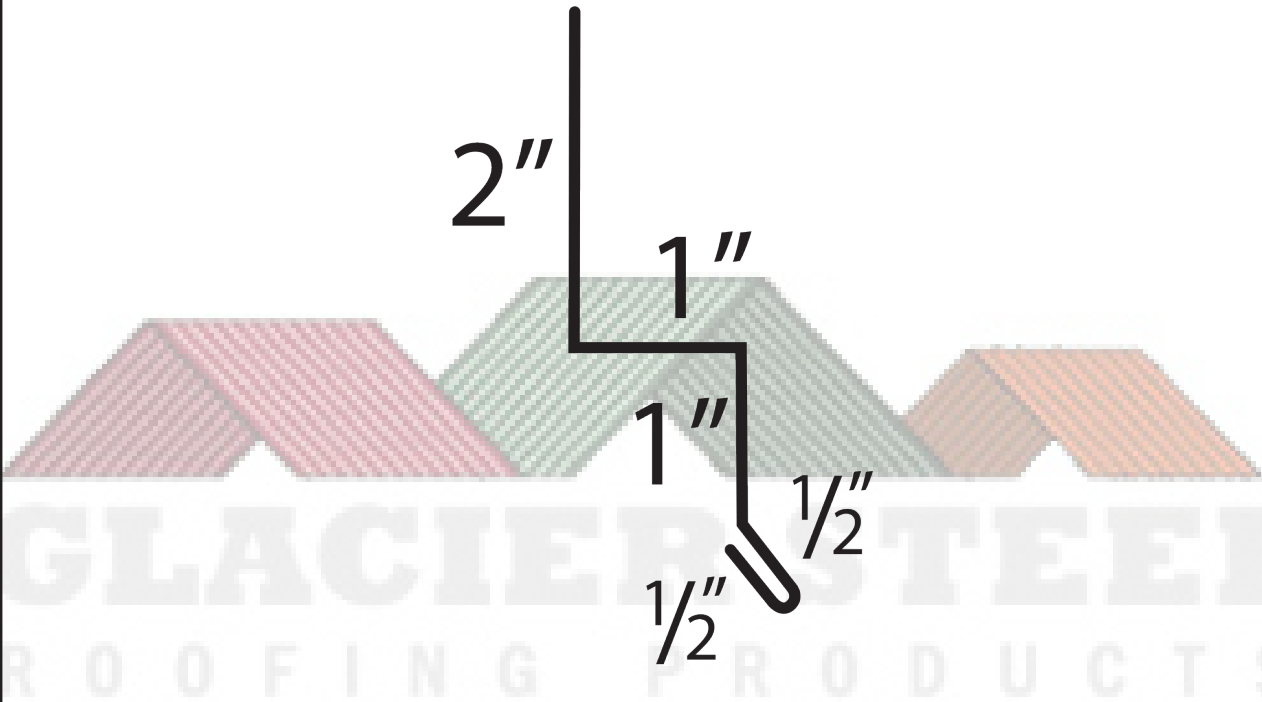

Wall Transition w/drip

5"



Glacier Steel
139 Alder Dr.
Kalispell, MT 59901
PH: 406.892.7525
FX: 406.892.7526

W W W . G L A C I E R S T E E L . C O M

29

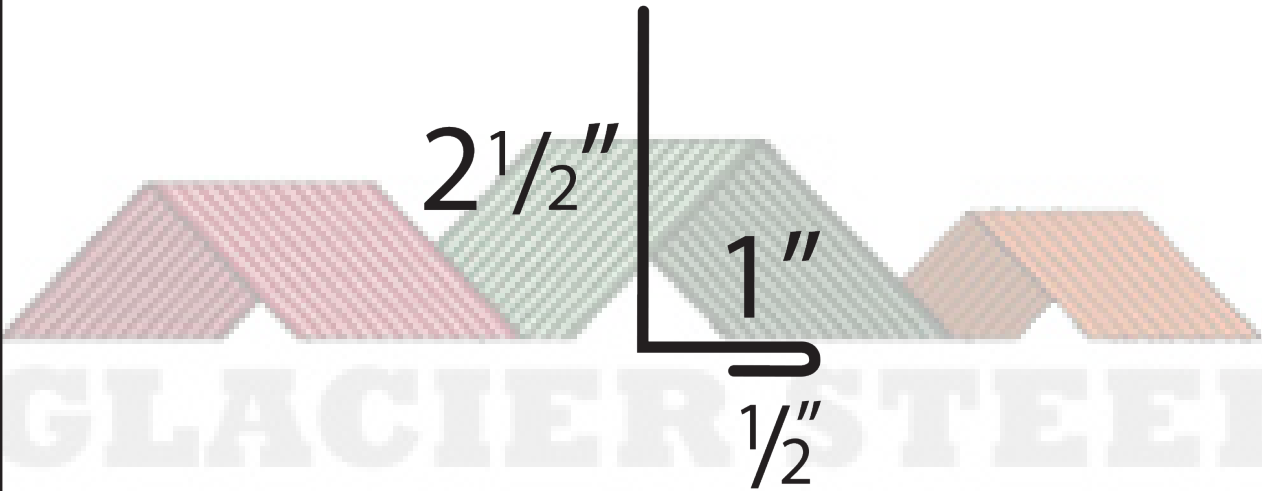

GLACIER STEEL
ROOFING PRODUCTS

Base w/o drip

4"



Glacier Steel
139 Alder Dr.
Kalispell, MT 59901
PH: 406.892.7525
FX: 406.892.7526

W W W . G L A C I E R S T E E L . C O M

30



Door Jamb



Glacier Steel
139 Alder Dr.
Kalispell, MT 59901
PH: 406.892.7525
FX: 406.892.7526

W W W . G L A C I E R S T E E L . C O M

31

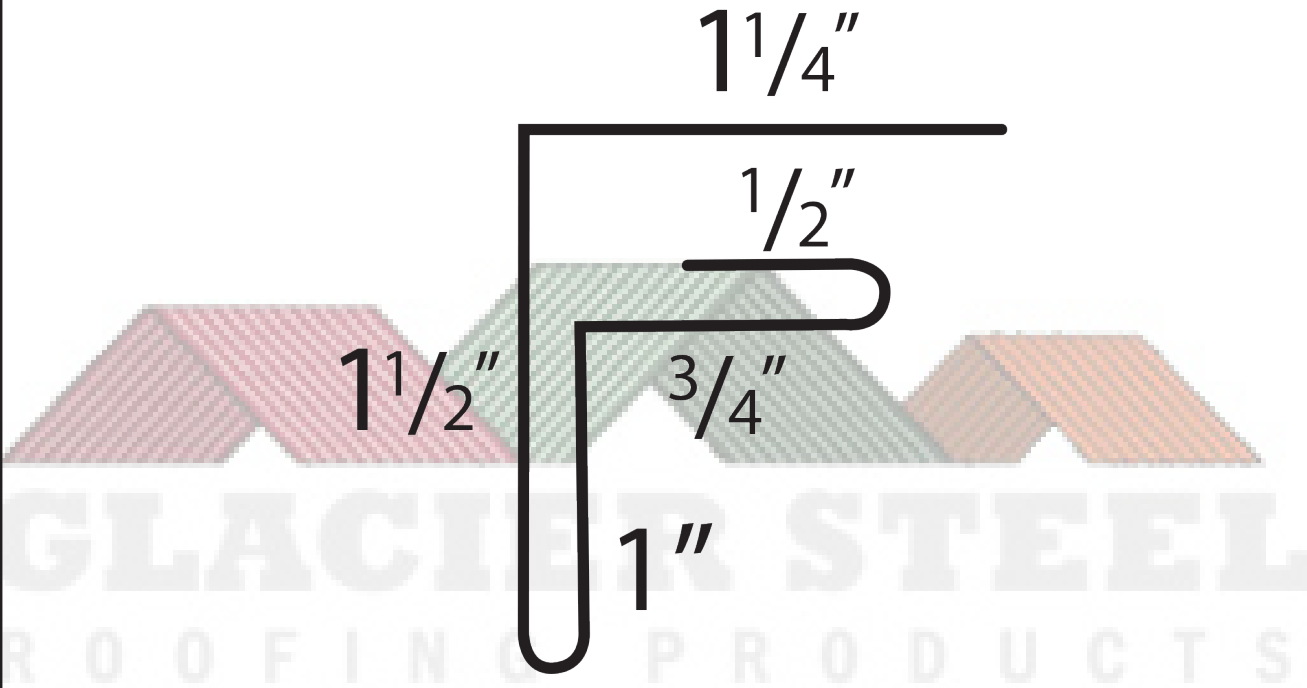

Soffit F Metal

5"



Glacier Steel
139 Alder Dr.
Kalispell, MT 59901
PH: 406.892.7525
FX: 406.892.7526

32

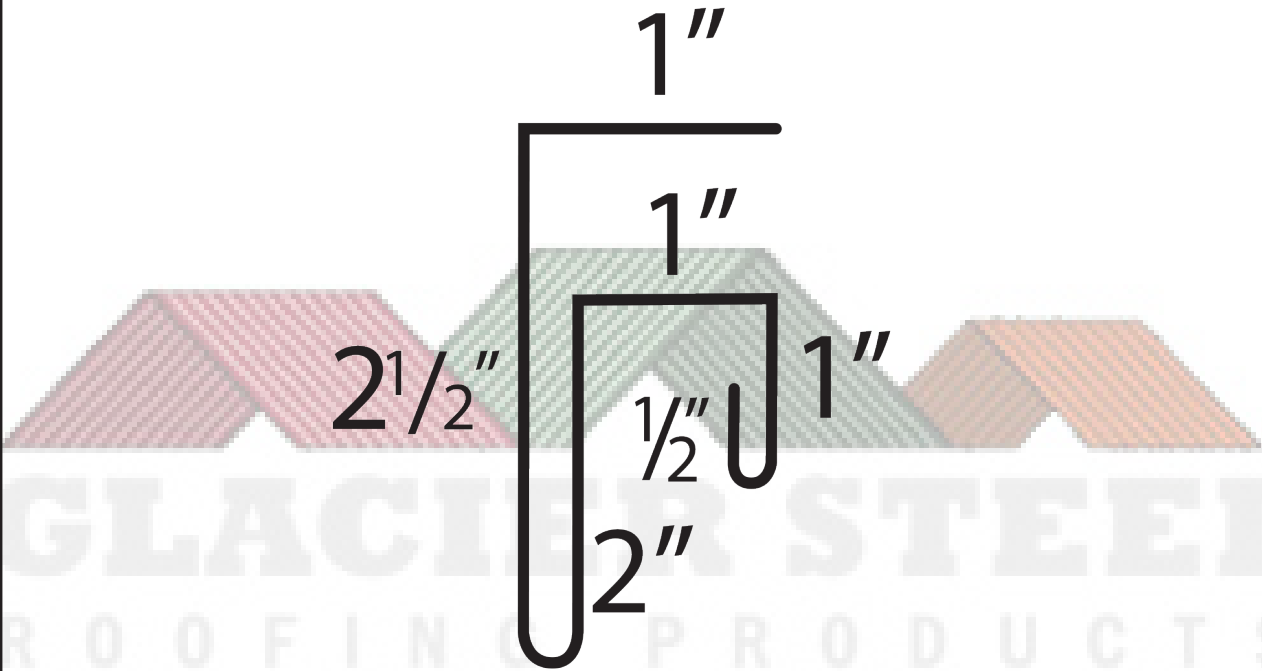

Soffit F&J Metal 8" 8"



Glacier Steel
139 Alder Dr.
Kalispell, MT 59901
PH: 406.892.7525
FX: 406.892.7526

W W W . G L A C I E R S T E E L . C O M

33

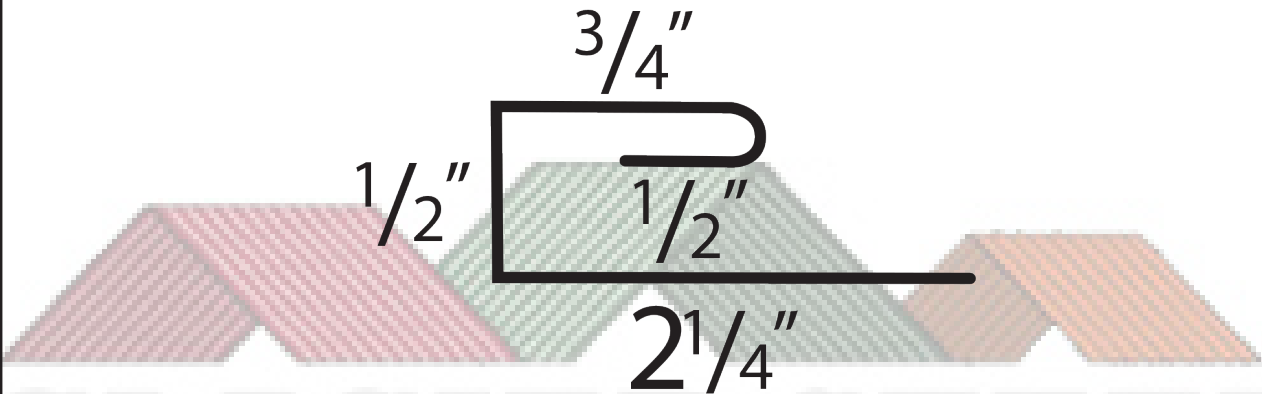

GLACIER STEEL
ROOFING PRODUCTS

Soffit J Metal

4"



Glacier Steel
139 Alder Dr.
Kalispell, MT 59901
PH: 406.892.7525
FX: 406.892.7526

W W W . G L A C I E R S T E E L . C O M

34

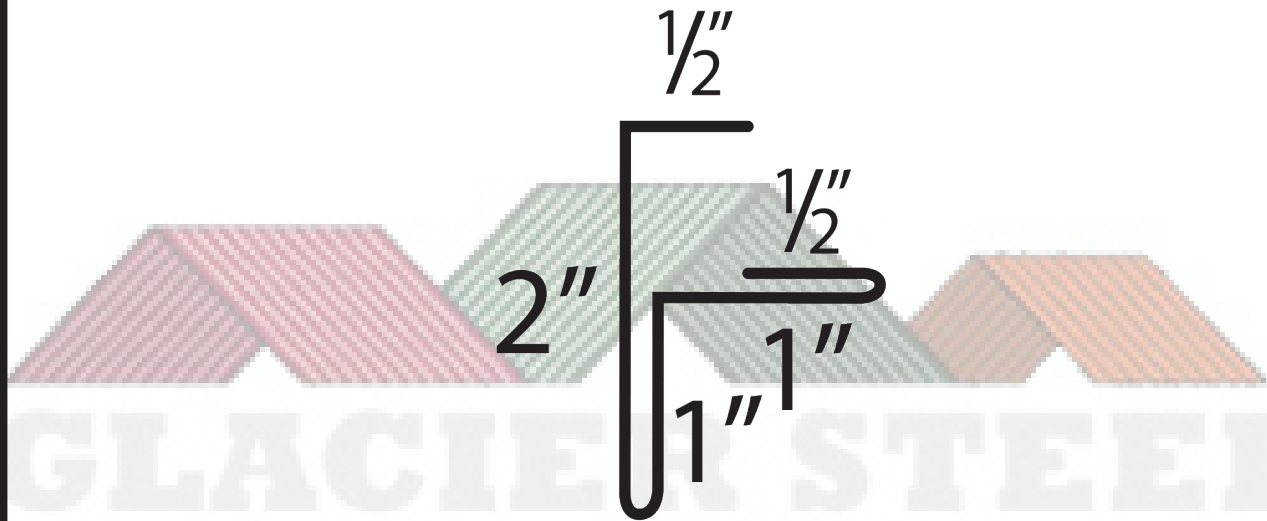

GLACIER STEEL
ROOFING PRODUCTS

F-Metal $\frac{3}{4}$ Rib

5"



Glacier Steel
139 Alder Dr.
Kalispell, MT 59901
PH: 406.892.7525
FX: 406.892.7526

W W W . G L A C I E R S T E E L . C O M

35

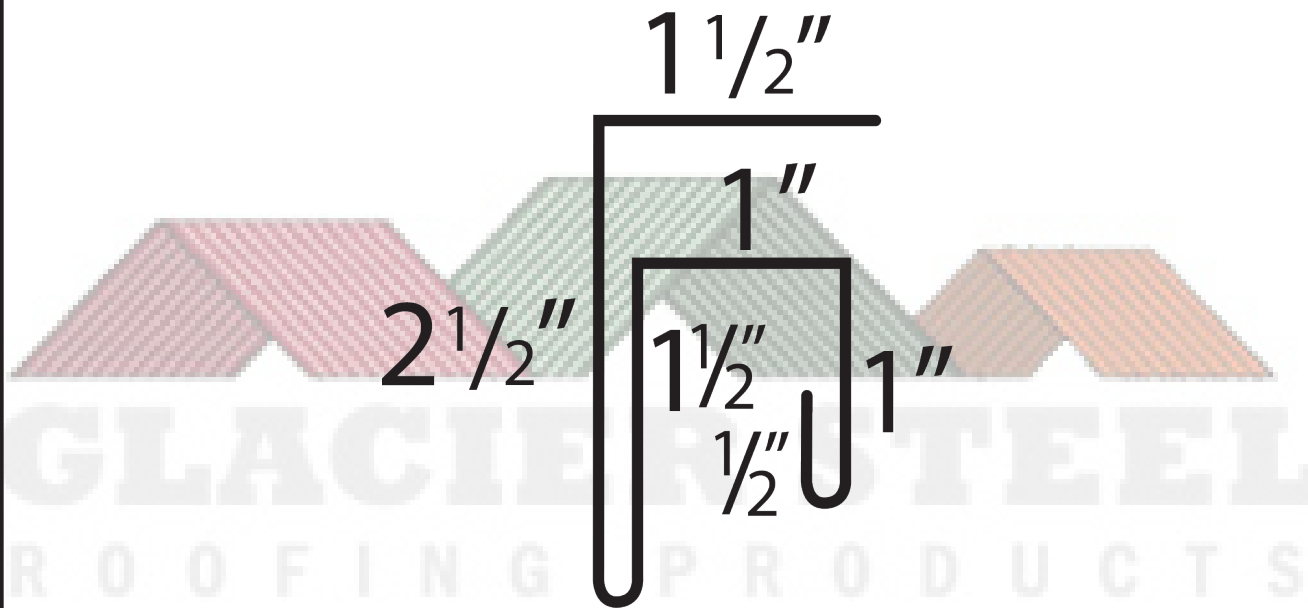

F&J ³/₄ Rib

8"



Glacier Steel
139 Alder Dr.
Kalispell, MT 59901
PH: 406.892.7525
FX: 406.892.7526

W W W . G L A C I E R S T E E L . C O M

36

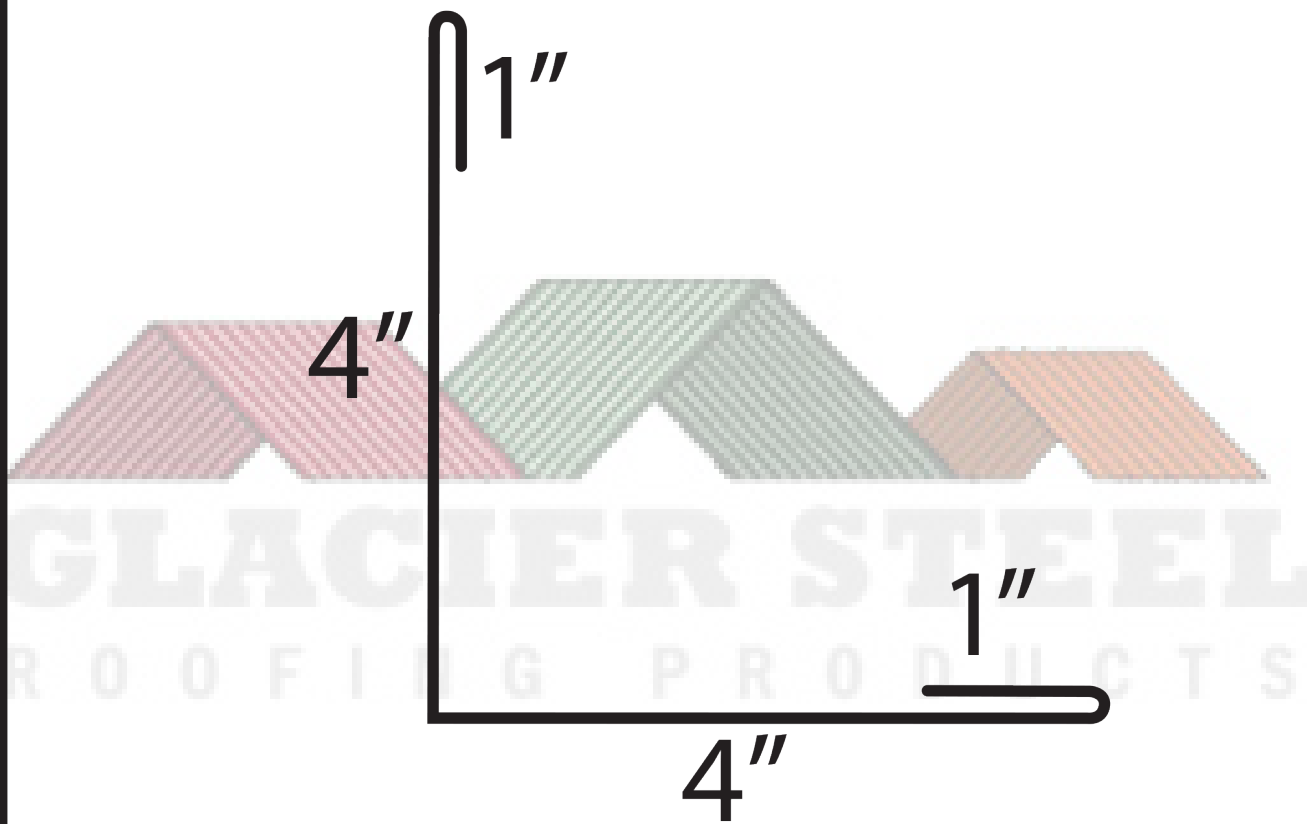

LP Outside Corner 10"



Glacier Steel
139 Alder Dr.
Kalispell, MT 59901
PH: 406.892.7525
FX: 406.892.7526

W W W . G L A C I E R S T E E L . C O M

37

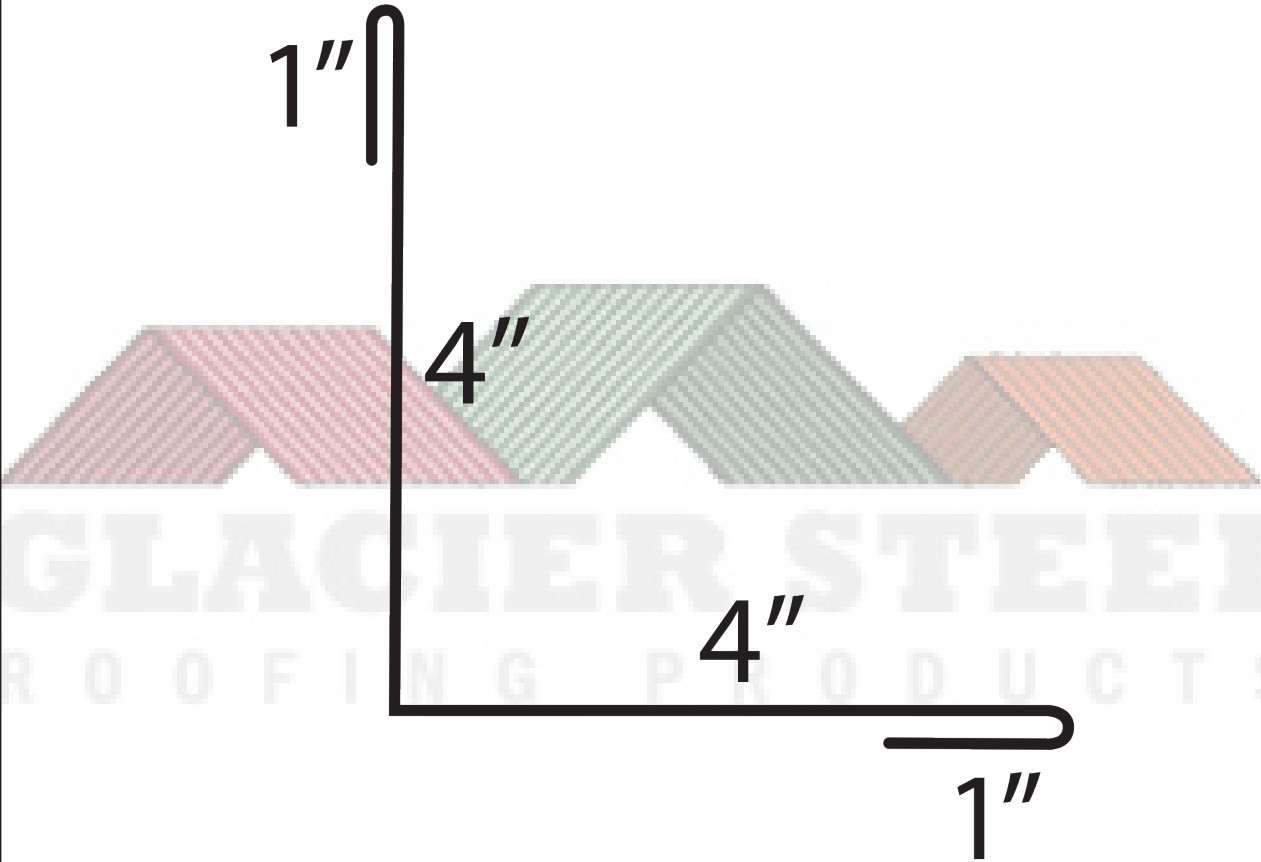

LP Inside Corner

10"



Glacier Steel
139 Alder Dr.
Kalispell, MT 59901
PH: 406.892.7525
FX: 406.892.7526

W W W . G L A C I E R S T E E L . C O M

38

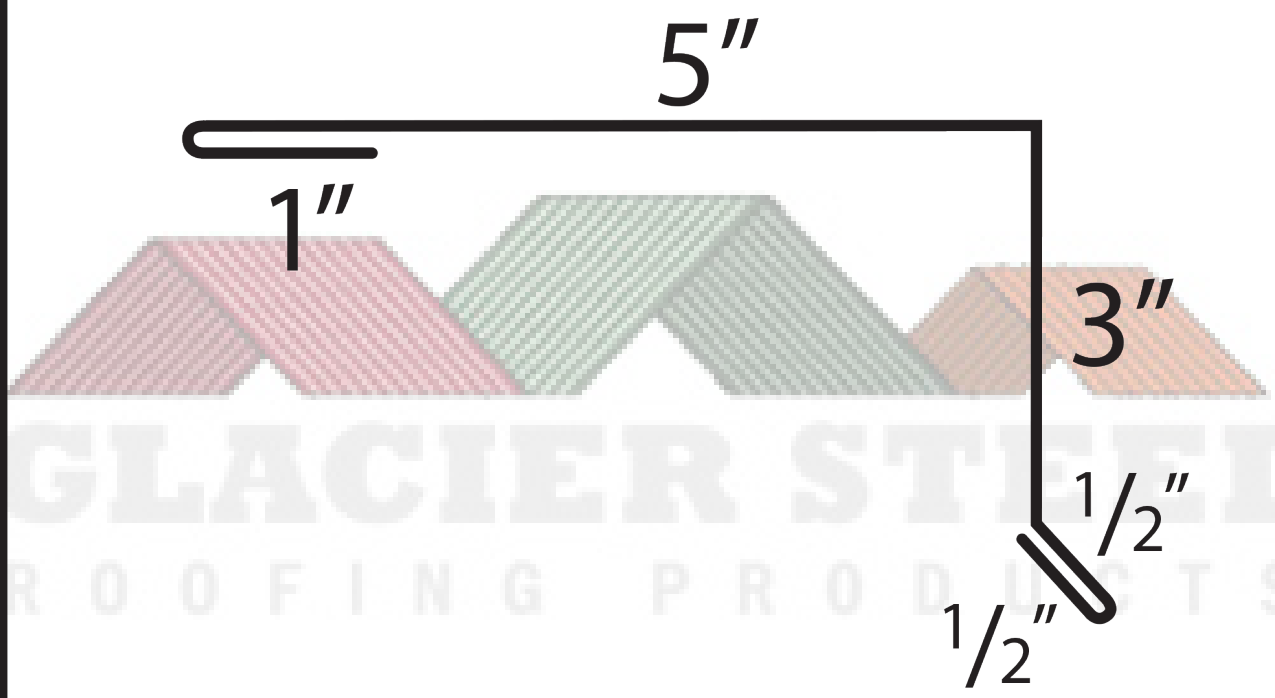

Mini Gable (corr.)

10"



Glacier Steel
139 Alder Dr.
Kalispell, MT 59901
PH: 406.892.7525
FX: 406.892.7526

W W W . G L A C I E R S T E E L . C O M

39

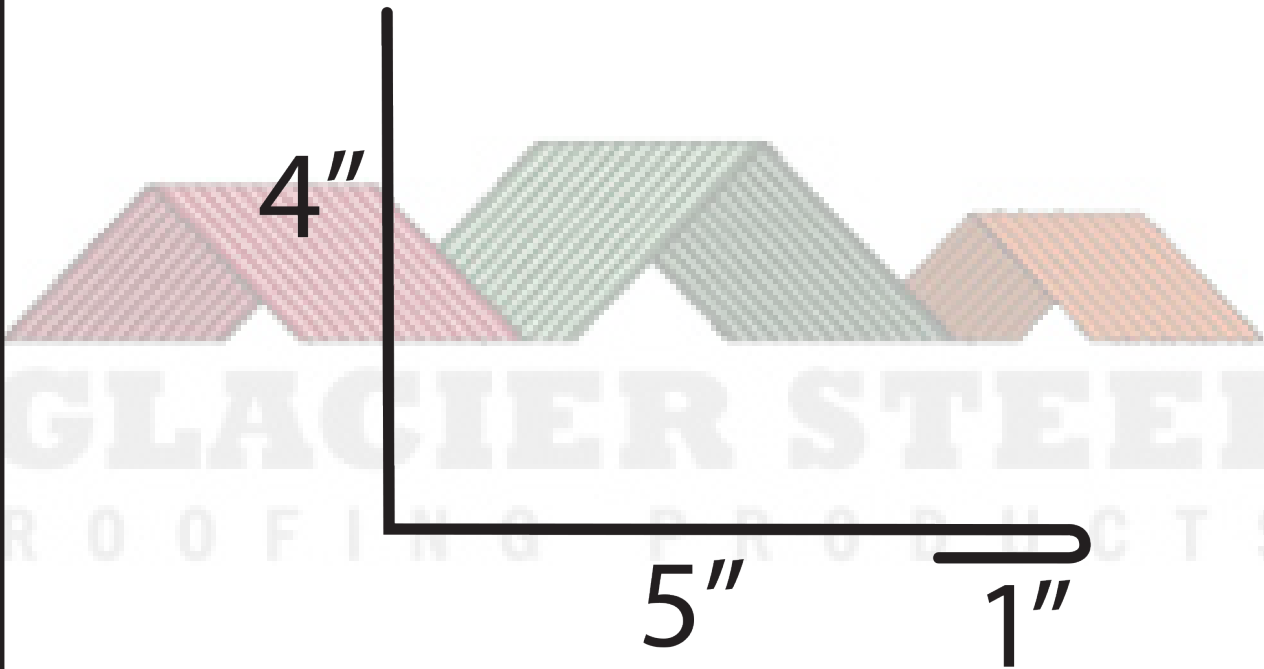

Sidewall (corr.)

10"



Glacier Steel
139 Alder Dr.
Kalispell, MT 59901
PH: 406.892.7525
FX: 406.892.7526

W W W . G L A C I E R S T E E L . C O M

40

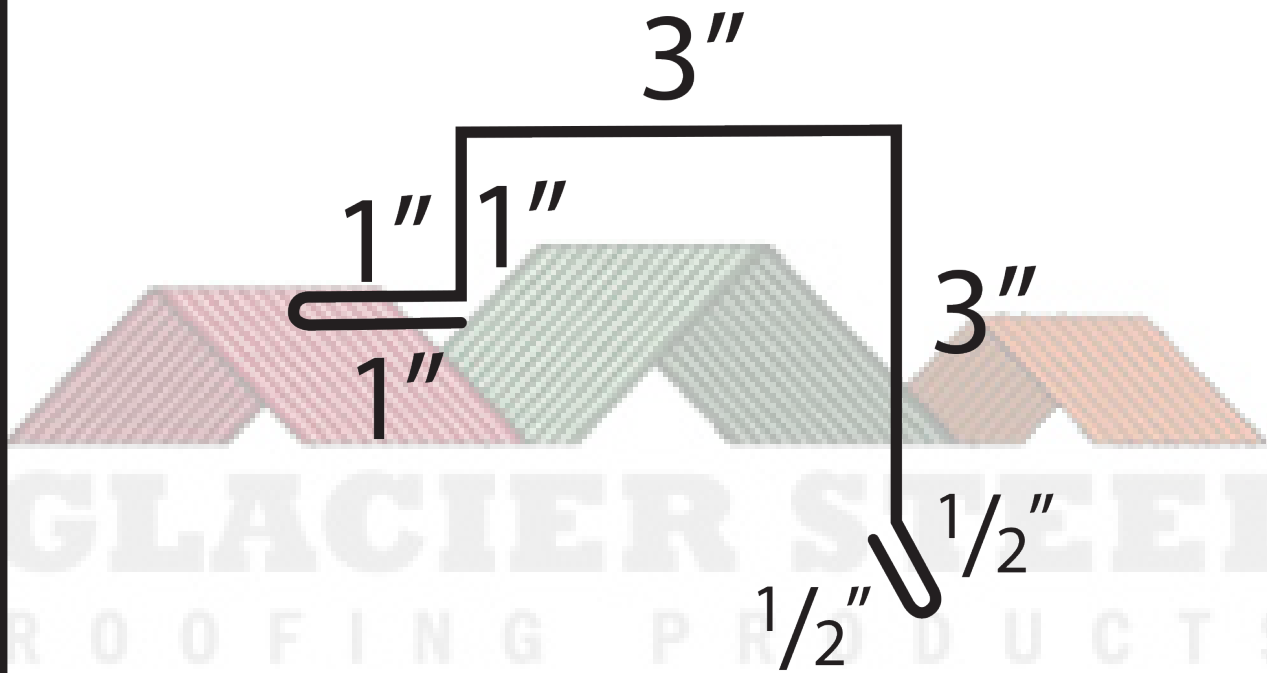

Mini Gable #1 (s/s) 10"



Glacier Steel
139 Alder Dr.
Kalispell, MT 59901
PH: 406.892.7525
FX: 406.892.7526

W W W . G L A C I E R S T E E L . C O M

41

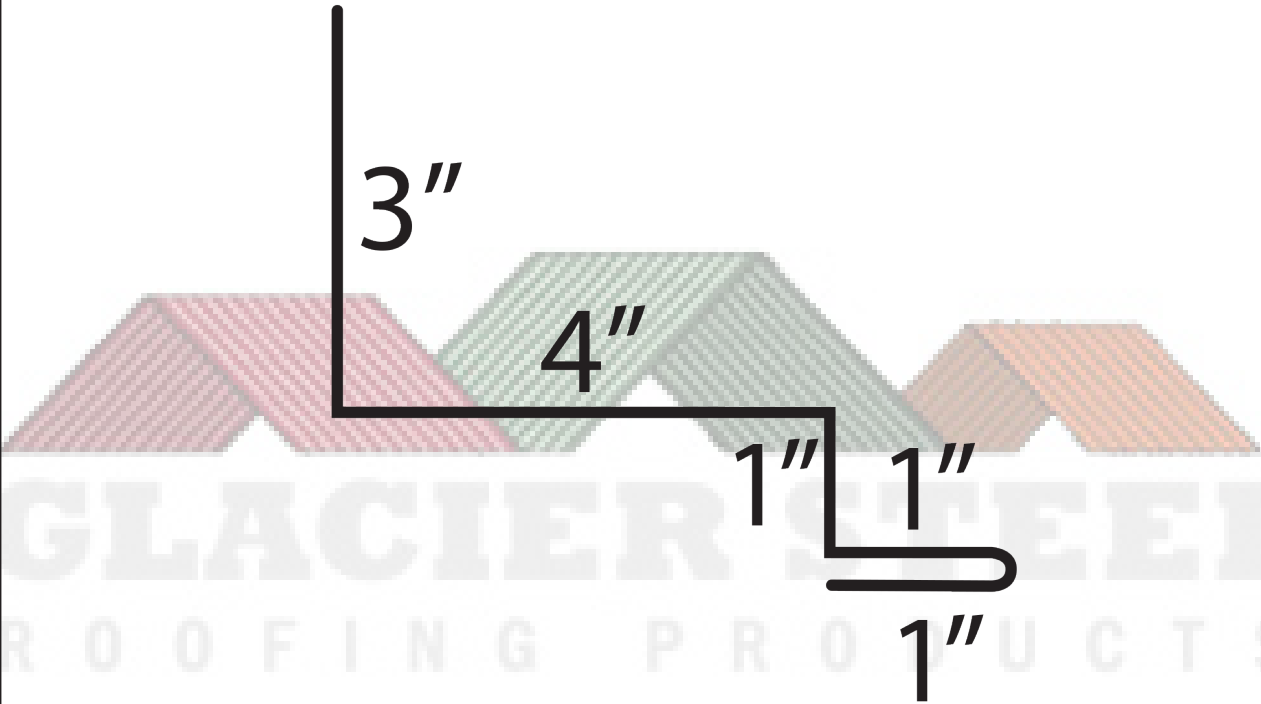

Sidewall #1 (s/s)

10"



Glacier Steel
139 Alder Dr.
Kalispell, MT 59901
PH: 406.892.7525
FX: 406.892.7526

W W W . G L A C I E R S T E E L . C O M

42

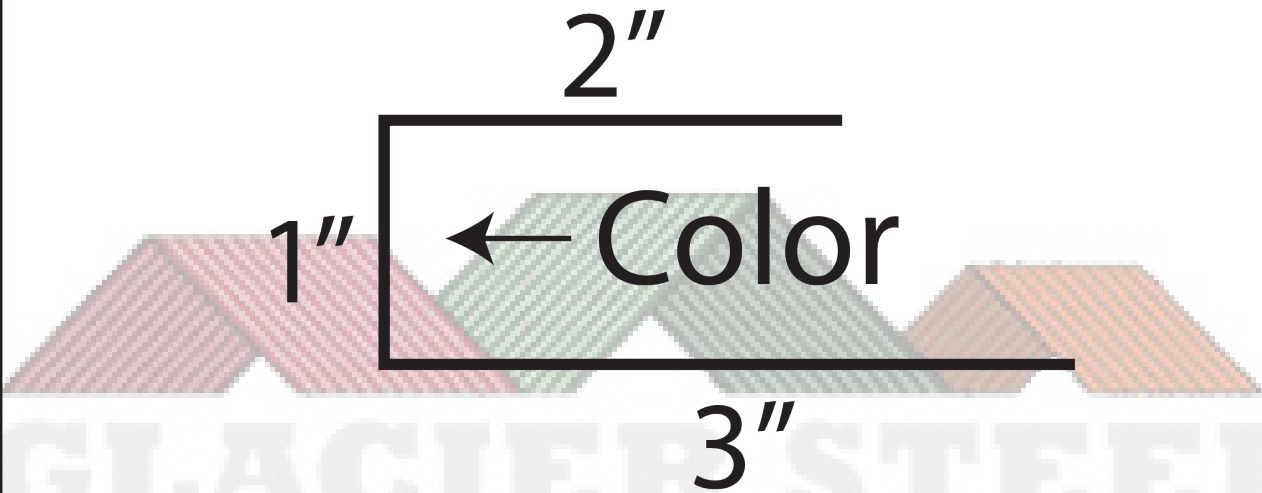

GLACIER STEEL
ROOFING PRODUCTS

S/S J-Metal

6"



Glacier Steel
139 Alder Dr.
Kalispell, MT 59901
PH: 406.892.7525
FX: 406.892.7526

W W W . G L A C I E R S T E E L . C O M

43

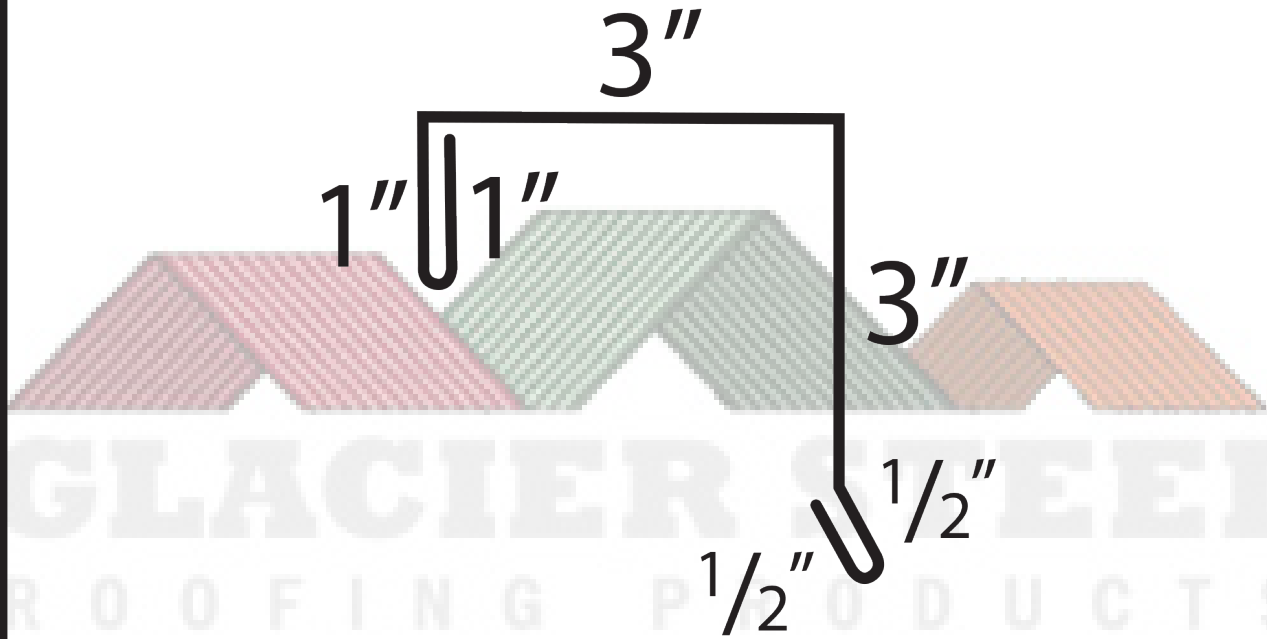

Mini Gable #2 (s/s) 9"



Glacier Steel
139 Alder Dr.
Kalispell, MT 59901
PH: 406.892.7525
FX: 406.892.7526

W W W . G L A C I E R S T E E L . C O M

44

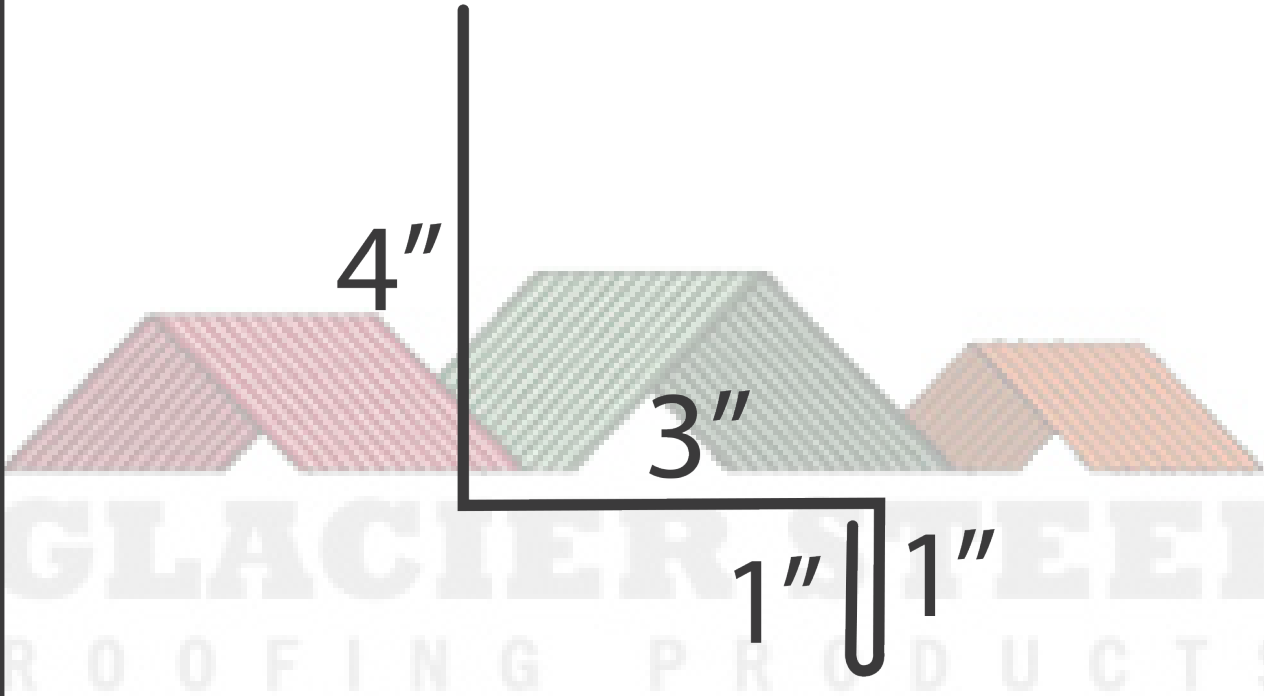

Sidewall #2 (s/s)

9"



Glacier Steel
139 Alder Dr.
Kalispell, MT 59901
PH: 406.892.7525
FX: 406.892.7526

W W W . G L A C I E R S T E E L . C O M

45

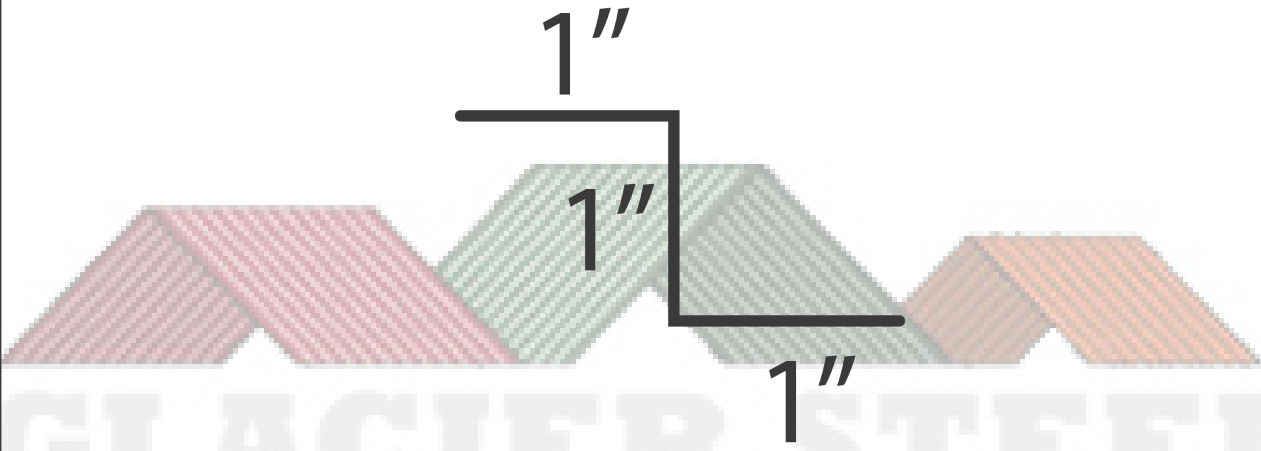

GLACIER STEEL
ROOFING PRODUCTS

S/S Z-Metal

3"



Glacier Steel
139 Alder Dr.
Kalispell, MT 59901
PH: 406.892.7525
FX: 406.892.7526

W W W . G L A C I E R S T E E L . C O M